

# ANALYSIS OF THE ELECTRO-OPTICAL FRONT END FOR THE NEW 40 GHz BUNCH ARRIVAL TIME MONITOR\*

A. Kuhl<sup>†</sup>, J. Rönsch-Schulenburg, J. Roßbach, Universität Hamburg, Germany  
 M.K. Czwalinna (née Bock), M. Bousonville, H. Schlarb, C. Sydlo, DESY, Hamburg, Germany  
 S.M. Schnepf, Laboratory for Electromagnetic Fields and Microwave Electronics (IFH),  
 ETH Zurich, Switzerland  
 T. Weiland, Institut für Theorie Elektromagnetischer Felder,  
 Technische Universität Darmstadt, Germany  
 A. Angelovski, R. Jakoby, A. Penirschke, Institut für Mikrowellentechnik und Photonik,  
 Technische Universität Darmstadt, Germany

## Abstract

The Free-electron LASer in Hamburg (FLASH) is currently equipped with four Bunch Arrival time Monitors (BAMs) which achieve a measurement accuracy below 10fs for bunch charges higher than 500pC. In order to achieve single spike FEL pulses at FLASH, electron bunch charges down to 20 pC are required. To achieve a measurement accuracy of 10 fs also at such a small bunch charge a new BAM containing new pickups with a bandwidth of up to 40 GHz has been designed and manufactured. The signal of the pickups will be evaluated using a time-stabilized reference laser pulse which is modulated with an Electro-Optical intensity Modulator (EOM). The theoretical measurement accuracy depends on several parameters and their fluctuations. The impact of these fluctuations on the measurement accuracy will be discussed.

## INTRODUCTION

The Free-electron LASer in Hamburg (FLASH) is a source of short photon pulses tunable within a wavelength range from 4.12 to 45 nm [1]. It is equipped with four Bunch Arrival time Monitors (BAMs), which provide a measurement accuracy below 10 fs for bunch charges above 0.5 nC [2]. In order to reach FEL pulses with a duration of a single mode only low bunch charges are required. For FLASH a bunch charge down to 20 pC is necessary [3]. Thus a BAM is required which allows the determination of the arrival time with a precision of 10 fs for bunch charges down to 20 pC. Therefore, a new pickup with a bandwidth of 40 GHz has been developed [4, 5, 6] and installed at FLASH. Besides the new pickup, a new electro-optical front-end is required for such a new BAM. The new front-end will use an electro-optical modulator (EOM) with a bandwidth of 40 GHz which corresponds to the bandwidth of the new pickup. Also a new readout electronic based on  $\mu$ TCA 4 [7] will be used. In order to preserve the large operating range of the bunch charges up to 3 nC a special wiring scheme is needed.

\*The work is supported by Federal Ministry of Education and Research of Germany (BMBF) within FSP 301 under the contract numbers 05K10GU2 and 05K10RDA.

<sup>†</sup>alexander.kuhl@desy.de

## PRINCIPLE OF MEASUREMENT

The arrival times of the electron bunches are detected with a pickup and compared with the timing of a laser pulse which is synchronized to a reference master oscillator. The new 40 GHz pickup contains four cone-shaped pick-up electrodes [4]. The electro-magnetic field of an electron bunch passing the BAM induces a short bipolar RF signal in each of the four pick-up electrodes. The RF signals of opposite pickup electrodes are combined to increase the amplitude and to reduce the influence on the orbit position of the electron bunches of the measured arrival time. One of these RF signals is directed to a 40 GHz EOM. This branch will be used as a fine channel with a high accuracy for the low bunch charge operation mode, but for high charges the amplitude of the pickup signal rises above the usable range of the EOM. The other branch is carried to a 10 GHz EOM (see Fig. 1). This branch will be used as coarse channel in low bunch charge mode and as standard channel for the high charge operation at FLASH. The laser pulse from the synchronisation system is approximately 100 times shorter than the RF signal pulse and the ratio of the laser amplitude of the output signal of the EOM ( $I_{out}$ ) and the input signal ( $I_{in}$ ) is given by the following equation [8]:

$$\begin{aligned}
 M_{\text{signal}} &= \frac{I_{\text{out}}}{I_{\text{in}}} \\
 &= \cos^2 \left( 2\delta_0 + \frac{2\pi U_{\text{bias}}}{U_{\pi, \text{bias}}} + \frac{2\pi U_{\text{RF}}(t)}{U_{\pi, \text{RF}}} \right) \\
 &= \frac{1}{2} + \frac{1}{2} \cos \left( \delta_0 + \frac{\pi U_{\text{bias}}}{U_{\pi, \text{bias}}} + \frac{\pi U_{\text{RF}}(t)}{U_{\pi, \text{RF}}} \right)
 \end{aligned} \tag{1}$$

The parameters  $\delta_0$ ,  $U_{\pi, \text{bias}}$ , and  $U_{\pi, \text{RF}}$  are device specific constants of the EOM. The intrinsic operation point is presented by  $\delta_0$ .  $U_{\pi, \text{bias}}$  and  $U_{\pi, \text{RF}}$  are the voltages to change the modulation  $M$  between 0 and 1 at the bias port respectively at the RF port. By setting the modulation to  $M = 0.5$  with a DC bias voltage  $U_{\text{bias}}$  an optimized determination of the timing difference between the RF and the laser pulse at the EOM are feasible. With a correct timing of the electron bunch, the zero-crossing of the RF signal reaches the EOM at the same time as the reference laser pulse and the output of the EOM will be  $M = 0.5$ . When the electron

bunch reaches the EOM with a timing offset the pickup signal shows a non-zero voltage at the RF input and therefore the amplitude of the laser pulse is modulated (see Fig. 2). The amplitude of the laser pulse is detected with a photodiode and digitized by a fast ADC. The performance of this system depends on the slope at the zero-crossing of the RF signal which directly depends on the electron bunch charge. Furthermore, a small jitter in the other components such as the reference laser pulse is necessary for a measurement accuracy in the order of 10 fs.

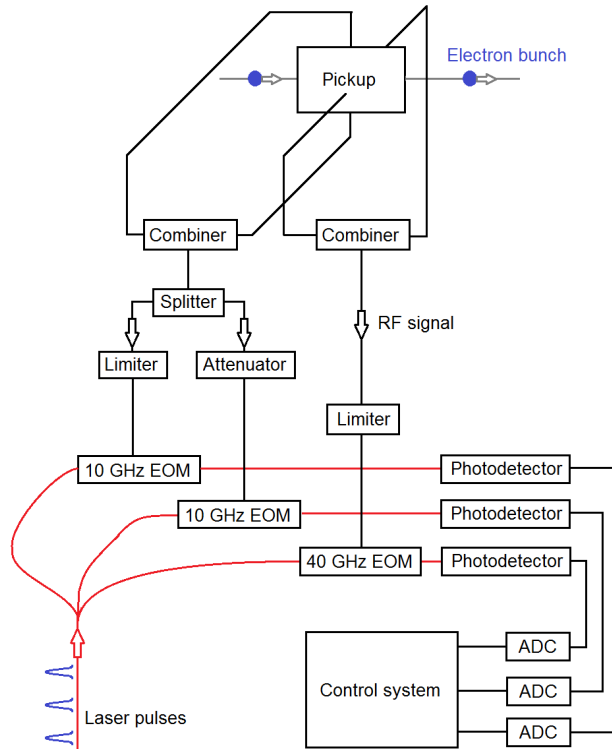

Figure 1: Schematic design of the BAM system.

## ANALYSIS MODEL

For a detailed analysis of the measurement accuracy of the new BAM the knowledge of the shape of the RF signal at the entrance of the EOM is required. The performance of the pickup has been simulated using CST PARTICLE STUDIO® [4, 6]. The simulation results of the new pickup were calculated directly behind the vacuum feedthroughs of the pickup electrodes. Additionally the RF cabling between the feedthroughs and the EOM changes the shape of the RF signal. The S-parameters have been measured for a 37 cm long RF cable. These results have been extrapolated to a 2.87 m long RF cable as it has been installed at the new BAM at FLASH. Furthermore, the RF combiner was considered with +2 dB (+3 dB by combination and -1 dB insertion loss). By using these extrapolated S-parameters the RF signal was calculated at the end of the cable. The resulting RF signal slope is 286 mV/ps and the amplitude at the entrance of the EOM is 1.463 V at a bunch charge of 20 pC. The RF signal and its slope and amplitude

ISBN 978-3-95450-119-9

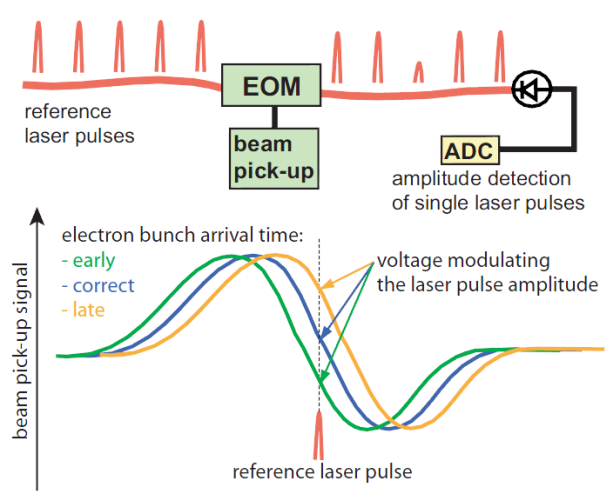

Figure 2: Principle of the arrival time measurement. The laser pulses are modulated by the EOM which is driven by the RF signal from the pickup. Arrival time changes of the electron bunch cause different modulation voltage at the laser pulse arrival time. [9]

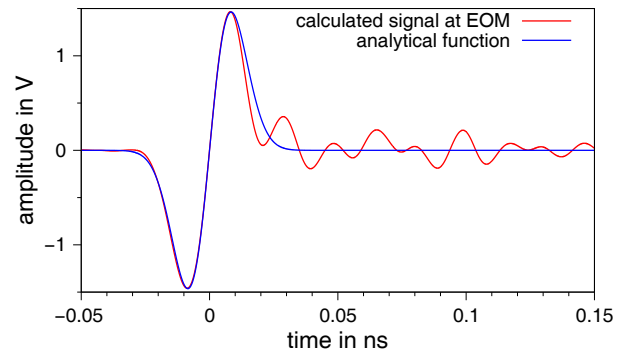

Figure 3: Comparison between the calculated RF signal with an electron bunch charge of 20 pC (blue) and the analytical function (red). The interesting area is around the first zero-crossing.

scales linearly with the bunch charge. For simplification it is advisable to use a deterministic function (see Fig. 3). Therefore, for further investigations the following analytical function, which corresponds to a derivative of the normally function, has been used to describe the RF signal

$$U_{RF}(t) = tS e^{-\frac{1}{e} \left(\frac{tS}{A}\right)^2} \quad (2)$$

with the slope at the zero-crossing  $S$  and the amplitude of the pickup signal  $A$ . The ringing of the RF signal is not of interest for this analysis. To avoid errors of the bunch arrival time measurement due to long-term drifts of  $\delta_0$  or  $U_{\pi, \text{bias}}$ , a baseline modulation will be detected during operation. This is possible because the repetition rate of the laser pulses (216.67 MHz which is one sixth of the 1.3 GHz reference source) is much higher than the repetition rate of the electron bunches (max. 1 MHz). Therefore a laser pulse before the one which is modulated by the RF signal of the pickup serves as a non-RF-modulated reference. These non-RF-modulated reference laser pulses will be detected

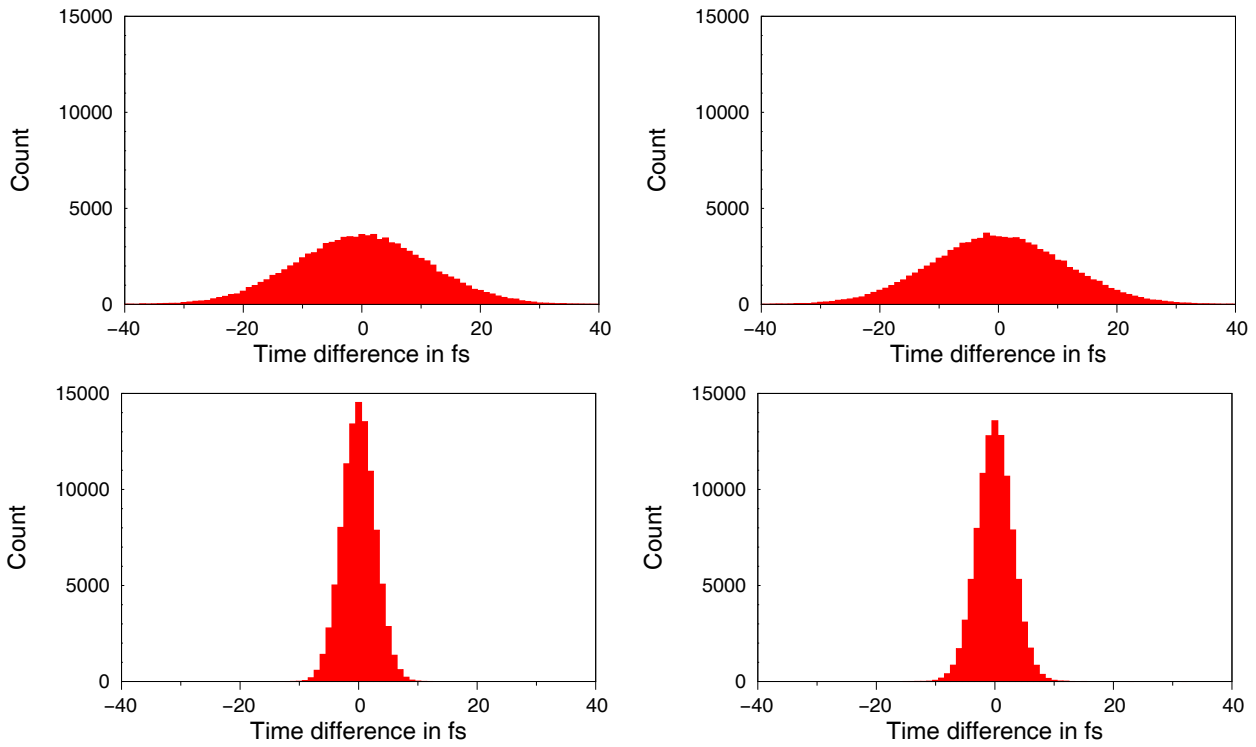

Figure 4: Count of the difference between  $t_{\text{bunch}}$  and  $t_{\text{sim,meas}}$  for different settings. The bunch charge is set to 20 pC in the top row and to 200 pC in the bottom row. The timing jitter of the bunch is set to 25 fs in the left column and to 100 fs in the right column.

as baseline modulation  $M_{\text{baseline}}$ . Compared with formula Eq. (1) we obtained:

$$M_{\text{baseline}} = \frac{1}{2} + \frac{1}{2} \cos\left(\delta_0 + \frac{\pi U_{\text{bias}}}{U_{\pi, \text{bias}}}\right) \underset{\text{set to}}{\approx} \frac{1}{2} \quad (3)$$

The real amplitude modulation can be calculated by:

$$M = M_{\text{signal}} - M_{\text{baseline}} \quad (4)$$

Furthermore a conversion from the real amplitude modulation of the laser pulse to the timing shift of the RF pulse and accordingly of the electron bunch is required. A linearization around the operating point of the RF signal leads to the calibration constant [8]

$$K = \frac{S}{2U_{\pi, \text{signal}}} \quad (5)$$

and therefore the simulated arrival time measurement is

$$t_{\text{sim,meas}} = \frac{\arcsin(2M)}{2K} \underset{\text{Taylor}}{\approx} \frac{M}{K} + \frac{2M^3}{3K} + \frac{6M^5}{5K} + \dots \quad (6)$$

### Monte Carlo Simulation

The performance of the bunch arrival time measurement depends on the stability of the laser pulse. Furthermore the noise of the bunch charge, the noise of bias voltage of the EOM, and the amplitude noise of the RF signal also influence the bunch arrival time measurements. The discrepancies of these values have been considered as normally distributed with an rms width given in Table 1. The

arrival time jitter of the electron bunch and therefore the measurement jitter has to be determined. The analysis was performed for different bunch charges. For one certain bunch charge the values of the real amplitude modulation  $M$  (Eq. 4) will be calculated. In the next step the simulated arrival time measurement  $t_{\text{sim,meas}}$  will be determined. This process will be repeated  $10^5$  times. For each of these calculations a different random set of the jitter parameters in Table 1 are generated. The simulated arrival time measurement value  $t_{\text{sim,meas}}$  differs from the set value of the arrival time  $t_{\text{bunch}}$ . Note,  $t_{\text{bunch}}$  is the arrival time which is also effected by jitter (see Table 1). The differences between  $t_{\text{bunch}}$  and  $t_{\text{sim,meas}}$  of each iteration were calculated (see Fig. 4). From all of these  $10^5$  samples the RMS of these differences were determined. This will be done for a set of different bunch charges.

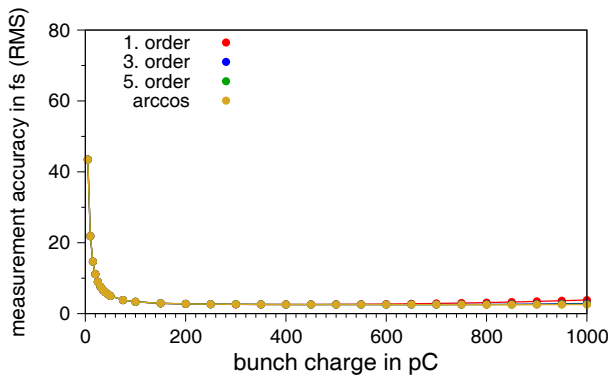

Figure 5: Calculated measurement accuracy of the BAM system at the 40 GHz EOM for different bunch charges with a timing jitter of 25 fs.

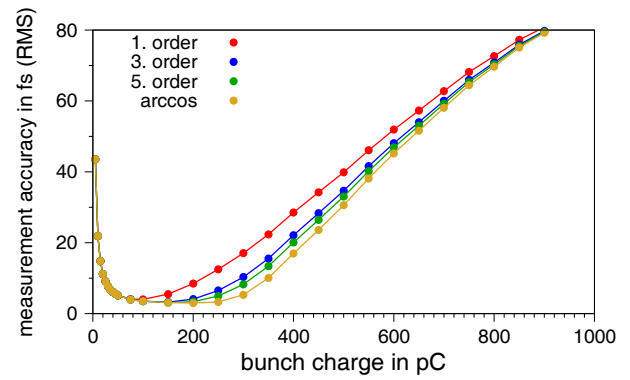

Figure 6: Calculated measurement accuracy of the BAM system at the 40 GHz EOM for different bunch charges with a timing jitter of 100 fs.

Table 1: List of Assumed Normally Distributed Jitter Values for the Monte Carlo Simulation

Parameter	assumed RMS values
bunch charge	1 %
bias voltage of the EOM	0.5 mV
RF voltage at the EOM	0.5 mV
laser amplitude <sup>1</sup>	0.35 %
laser timing	2.5 fs
ADC channel	20
bunch arrival time <sup>2</sup>	25 fs and 100 fs

<sup>1</sup> Only for the calculation of the  $M_{\text{signal}}$ .

<sup>2</sup> Stored and compared to the simulated measurements for each iteration.

Figure 4 exemplary shows the results for two different charges. For a bunch charge of 20 pC the calculation of the performance of the new BAM achieved a measurement accuracy of about 11 fs (RMS). The measurement jitter improves slightly if the arrival time jitter of the electron bunches decreases. A reduction of the arrival time jitter down to 25 fs is possible by using the intra bunch train feedback at FLASH [10]. The measurement jitter for different bunch charges is shown in Fig. 5 and 6. The results are calculated applying different orders of Equation (6). Increasing the bunch charge starting from 5 pC the measurement jitter will be reduced down to 4 fs. For a bunch arrival time jitter of 100 fs the measurement jitter is starting to degrade above 250 pC. This is because of the unambiguity of the modulation in the EOM is lost when  $U_{\text{RF}} > \frac{1}{2}U_{\pi,\text{RF}}$  according to Eq. (3). As result the  $T_{\text{sim,meas}}$  can not be calculated correctly with Eq. (6). This failure will also occur in the real BAM system. Figure 7 shows the relative incidence of  $U_{\text{RF}}$  which is greater than  $\frac{1}{2}U_{\pi,\text{RF}}$ . For bunch charges above approximately 200 pC the 10 GHz EOM has to be used as the fine channel for the arrival time measurement.

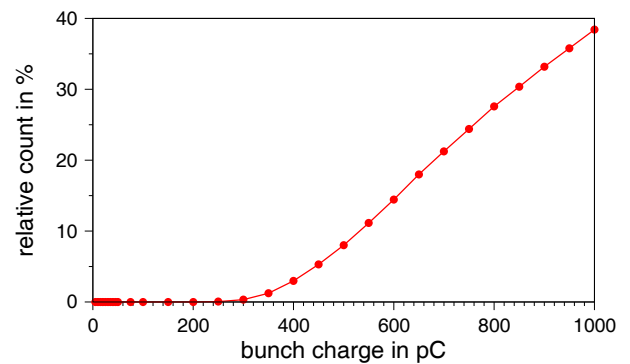

Figure 7: The working range of the EOM for detecting the correct timing is limited by  $\frac{1}{2}U_{\pi,\text{RF}}$ . The graph shows the relative count with  $U_{\text{RF}}$  higher than  $\frac{1}{2}U_{\pi,\text{RF}}$  for different bunch charges by using a timing jitter of 100 fs. For bunch charges higher than 200 pC the 10 GHz EOM has to be used as the fine channel for measurement of the timing shift.

## CONCLUSION AND OUTLOOK

A new 40 GHz BAM was designed and simulated [4]. The performance of the BAM system was calculated with simplified mathematical models including various jitter sources. The calculation reaches a measurement accuracy of approximately 11 fs for a bunch charge of 20 pC and better than 10 fs for bunch charges higher than 25 pC. Compared with the currently running 10 GHz BAM system which achieves a measurement accuracy below 10 fs for bunch charges above 500 pC, the new system will be a significant improvement. It also has been observed that the jitter of the laser amplitude has the strongest influence on the measurement accuracy for low bunch charges. An improvement of this jitter to 0.2 % would result in a measurement accuracy below 10 fs for 15 pC bunch charge. The new BAM pickup has been installed at FLASH. The next steps are the manufacturing and installation of the new electro-optical BAM front end.

**REFERENCES**

- [1] K. Honkavaara et al., “Status of FLASH”, TUPPP052, Proceedings of IPAC 2012, New Orleans, USA.
- [2] M.K. Bock et al., “Recent Developments of the Beam Arrival Time Monitor with Femtosecond Resolution at FLASH”, WEOCMH02, Proceedings of IPAC 2010, Kyoto, Japan.
- [3] J. Rönisch-Schulenburg et al., “Generation of Ultra-Short Electron Bunches at FLASH”, THPD33, will be published at FEL 2012, Nara, Japan.
- [4] A. Angelovski et al., “High Bandwidth Pickup Design for Bunch Arrival-time Monitors for Free-Electron Laser”, will be published at Physical Review Special Topics - Accelerators and Beams (PRST-AB), 2012.
- [5] A. Angelovski et al., “Realization of a High Bandwidth Bunch Arrival-time Monitor with Cone-shaped Pickup Electrodes for FLASH and XFEL”, TUPC076, Proceedings of IPAC 2011, San Sebastián, Spain.
- [6] A. Kuhl et al., “Sensitivity and Tolerance Analysis of a new Bunch Arrival Time Monitor Pickup Design for FLASH and XFEL”, TUPC079, Proceedings of IPAC 2011, San Sebastián, Spain.
- [7] [www.struck.de/nss11xtcaws.pdf](http://www.struck.de/nss11xtcaws.pdf)
- [8] M.K. Bock, “Measuring the Electron Bunch Timing with Femtosecond Resolution at FLASH”, dissertation, Hamburg 2012, Germany.
- [9] F. Loehl et al., “Electron Bunch Timing with Femtosecond Precision in Superconducting Free-Electron Laser”, published at Physical Review Lett. 104, 144801, 2010.
- [10] C. Schmidt et al., “Feedback Strategies for Bunch Arrival Time Stabilization at FLASH Towards 10 fs”, THPA26, Proceedings of FEL 2011, Shanghai, China.