

Konrad PRZYGODA, Tomasz POŻNIAK, Andrzej NAPIERALSKI  
Katedra Mikroelektroniki i Technik Informatycznych, Politechnika Łódzka

Mariusz GRECKI  
Group of Maschine Strahlkontrollen, Deutsches Elektronen-Synchrotron

## SYSTEM MONITOROWANIA I KOMPENSACJI Odstrojenia REZONANSOWYCH WNEK NADPRZEWODZĄCYCH Z WYKORZYSTANIEM ELEMENTÓW PIEZOELEKTRYCZNYCH

**Streszczenie.** W artykule opisano system mechatroniczny do kompensacji i monitorowania odstrojenia rezonansowych wnęk nadprzewodzących z wykorzystaniem elementów piezoelektrycznych. System został zainstalowany i podłączony do piezoelektrycznych elementów wykonawczych wykorzystywanych w akceleratorze FLASH w ośrodku badawczym Deutsches Elektronen-Synchrotron (DESY) w Hamburgu. Ponadto część monitorująca systemu została wykorzystana do pomiaru sygnałów odczytanych z czujników piezoelektrycznych. Zaprezentowano pierwsze wyniki analiz oraz modelowania uzyskanych funkcji przejścia systemu.

**Słowa kluczowe:** sterowania piezoelementów, oddziaływanie sił Lorentza, akcelerator liniowy

## SYSTEM FOR MONITORING AND COMPENSATION OF SUPERCONDUCTING RESONANT CAVITIES DETUNING WITH PIEZOELECTRIC ELEMENTS

**Summary.** The paper presents mechatronic system for compensation and monitoring of superconducting resonant cavities detuning with piezoelectric elements. This system was installed and connected to all available piezo tuners in FLASH accelerator in research center of Hamburg. Moreover, the monitoring part of the system was used to measure signals from piezo tuner frames operated as sensors. The first data analysis and analytical fitting of derived transfer functions are briefly summarized.

**Keywords:** piezo control system, Lorentz force detuning, linear accelerator

### 1. INTRODUCTION

The Free Electron Lasers (FELs) are a unique pulsed light sources which are used for a variety of modern sciences including medicine, biology, pharmacy as well as material

research. The wavelength of generated spontaneous radiation is tunable in range of 100÷10 nm, which makes it suitable for exploration of very small structures. Linear particle accelerators (linacs) use superconducting (SC) resonant cavities for particle acceleration, operated at a radio frequency (RF) of a few GHz. The SC cavities are detuned from its resonance commonly due to repulsive magnetic forces and attractive electric forces (Lorentz forces) of an electromagnetic wave which is transferred to the cavity as a set of successively repeated pulses. The even a micrometer change of the cavity dimensions can cause its detuning from resonance of hundred of Hz. The detuned cavities need more RF control efforts to achieve a desired energy of accelerated particles [1]. Therefore, the electromechanical structures commonly based on piezoelectric elements are used to tune the cavities to the resonance frequency. In order to achieve the demand requirements for piezo control, the dedicated electronic systems were designed and developed.

## 2. FLASH ACCELERATOR

The Free Electron LASer in Hamburg (FLASH) is one of the worldwide leading light source. The FLASH linac can deliver a bright, high energy electron beams which can generate spontaneous radiation of wavelength less than 10 nm. The particle source at FLASH is a photoinjector (laser), where the electrons are produced by means of photoeffect. Particles are further accelerated downstream the RF gun and accelerating structures (cryomodules) to the required energy for FEL operation of about 1 GeV. The acceleration is achieved by the alternating fields of 9-cell resonators build from pure niobium (see Tab. 1). When properly matched to the generator frequency, RF resonators can build up high alternating electric fields with low power losses. The resonators are helium-cooled and operated at a temperature of 1.7 K, where niobium is superconducting (TESLA technology). At FLASH, eight nine-cell superconducting cavities are grouped into cryomodules. Single RF generator - klystron (5÷10 MW) serves from one to three accelerating modules (see Fig. 1). The klystron can generate RF electromagnetic wave of frequency of 1.3 GHz, repeated up to ten times per second with pulse width of 2 ns [2].

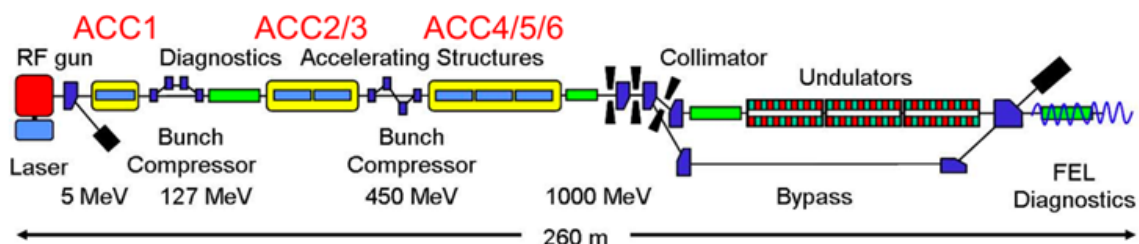

Fig. 1. The block diagram of FLASH accelerator  
Rys. 1. Schemat blokowy akceleratora FLASH

Table 1

The main parameters of TESLA cavity

length	1 m
no. of cells	9
material	niob
quality factor QL	$3 \cdot 10^6$
electrical resonance frequency	1.3 GHz
mechanical resonance frequency	300 Hz
detuning sensitivity	315 Hz/ $\mu\text{m}$

## 2.1. Piezo control in FLASH

The cavities are tuned to desired resonance frequencies using electromechanical tuners. The slow frequency tuners commonly based on step motors are used to pre-detuning compensation. Their operating range is of order of 500 kHz per minute. Since the step motor tuners cannot be used to counteract the mechanical deformations of the cavity caused by RF pulse, the fast frequency piezo tuners are used (see Fig. 2 left). The operating range of the piezo tuners is of order of a few kHz and they can be used for active compensation of time varying detuning. The Noliac and Physik Instruments (PI) companies are the main providers for such elements used for high energy physics. The main fabrication parameters of the piezo elements can be found in [3]. The piezos installed in FLASH are configured as follows: the ACC3 and ACC5 have tuners with single piezo (Noliac and PI) while the ACC6 has double piezos from PI. The tuners with double piezos can be used simultaneously as actuator and sensor. In order to handle such piezo configuration, the corresponding piezo control system was designed and installed in FLASH (see Fig. 2 right). It is equipped with three units of 8-channel piezo driver, 32-channel driving/sensing board (Piezo Control Board), Low-Level Radio Frequency (LLRF) control board (SimconDSP), industrial CPU (Sparc), Distributed Object Oriented Control System (DOOCS) and monitoring ADCs [4]. The piezo driver units are used to control the frequency tuners with proper voltage levels. In order to assure the demand lifetime of the piezo elements the power amplifiers were equipped with overvoltage and overcurrent protection circuits. The Piezo Control Board is used to operate the driving (DAC) and sensing circuits (PZS). The board allows generating low voltage compensation signals as well as monitoring the piezo elements operated as sensors. The LLRF board – SimconDSP is used to redistribute the control tables for corresponding input/output channels. The both control boards were connected using fiber optics to avoid the problems with cables length as well as makes the system robustness to the hardness radiation environment. The control application running on a Sparc CPU is responsible for measurements of the cavity response (via monitoring ADCs and downconverters - DWN) and preparation of the correction signals according to the actual cavity detuning.

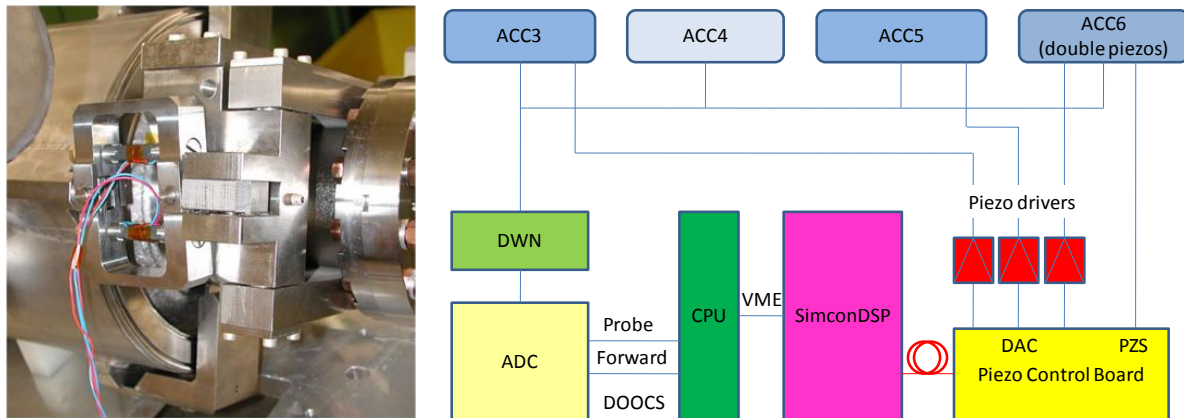

Fig. 2. Frequency tuner based on double piezoelectric elements (left), piezo control system in FLASH (right)

Rys. 2. Stroik częstotliwości posiadający dwa układy piezoelektryczne (po lewej), system sterowania piezo dla akceleratora FLASH (po prawej)

## 2.2. The system requirements

The general requirements of the piezo control system are:

- compensate of dynamic Lorentz force detuning (LFD) during the flat top of RF pulse in range of  $\Delta f < 10$  Hz for accelerating fields up to 30 MV/m,
- provide constant offset of  $\Delta f$  during the flat top of RF pulse,
- allow suitable operation for maximum repetition rate of RF pulse of 10 Hz,
- allow tuning and by-passing cavities in limited range instead of using step motors,
- minimize the RF control efforts,
- assure piezo lifetime for at least 20 years operation- piezo must be protected and monitored.

## 3. LORENTZ FORCE DETUNING (LFD) COMPENSATION IN FLASH

The piezo control system was used to tune the 23 cavities in FLASH during the high gradient and high current beam acceleration (9mA) tests performed in September 2009. The piezos installed in cavity 5 of ACC6 were not available due to the known problem of broken mechanical contact between piezo and cavity. The FLASH accelerator was operated in pulse mode (5 Hz repetition rate of RF pulse) with high accelerating field gradients up to 30 MV/m. The Lorentz force detuning compensation for accelerating module ACC3 is shown in Fig. 3. It is clearly visible that the dynamic Lorentz force detuning during the flat top region (time period between  $(600 \div 1400)$   $\mu$ s) was measured and compensated from around 300 Hz up to single Hz.

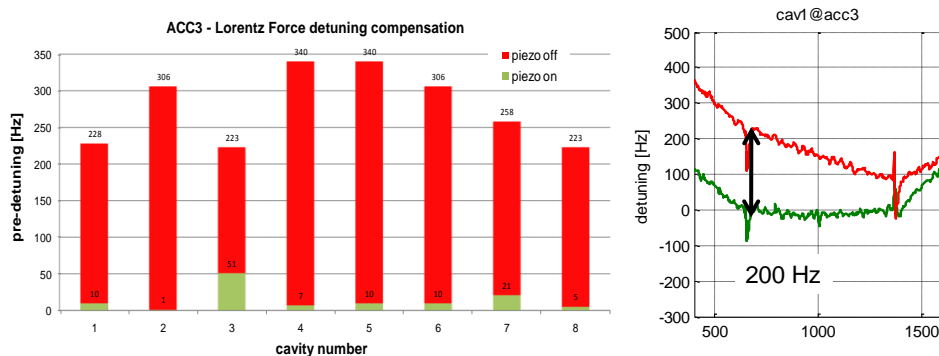

Fig. 3. Lorentz force detuning compensation with piezo tuners in ACC3 (left), LFD online measurements (right)

Rys. 3. Wynik kompensacji odstrojenia spowodowanego siłami Lorentza (po lewej), pomiary odstrojenia w czasie rzeczywistym (po prawej)

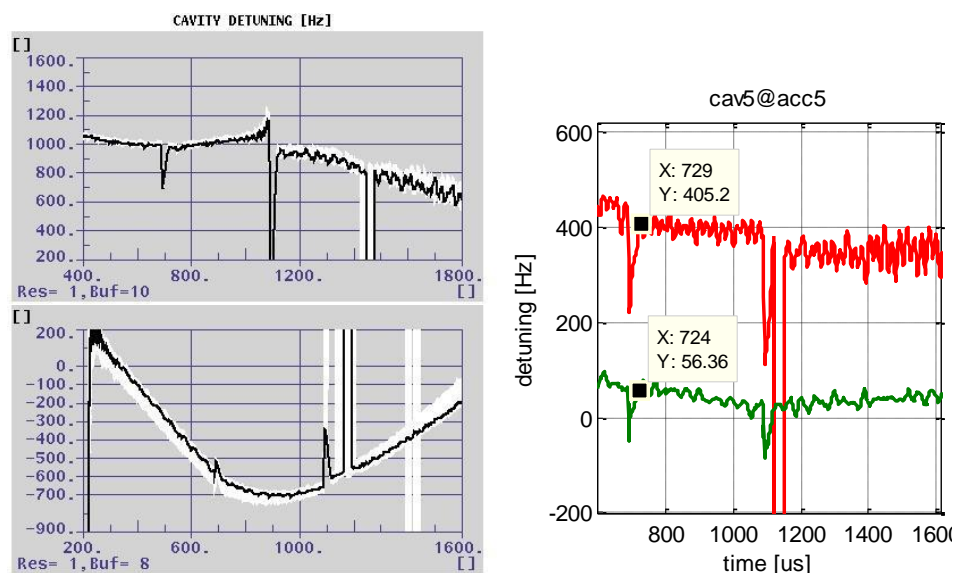

Fig. 4. Cavity tuning and bypassing possibility investigations using piezo tuners, on the left side a multi-pulse method, on the right a single pulse tuning

Rys. 4. Badanie możliwości strojenia i odstrajania wnęki z wykorzystaniem stroików, po lewej stronie metoda wielopulsowa, po prawej metoda z pojedynczym pulsem

The static detuning, which means the offset of the detuning curve from 0 Hz on the vertical axis, was reduced and kept constant during active compensation. The tuning and bypassing possibility of the corresponding cavities was investigated using the single and multi-pulse compensation techniques. The single pulse compensation method was capable of tuning cavity in range of  $\pm 500$  Hz, while the multi-pulse approach allows increasing the tuning range up to  $\pm 1$  kHz (see Fig. 4).

Finally, the main cavity parameters as forward power, accelerating field (probe signal) as well as reflected power were measured first without and next with compensation. The reduction of RF control efforts as well as increase of acceleration efficiency are summarized in table 2.

Table 2

RF control efforts estimation during compensation in ACC3

cavity no.	forward power		accelerating field		reflected power	
	kW	diff.	MV/m	diff.	kW	diff.
		%		%		%
1	115.8	-11.3	19.4	+7.7	25.3	-7.3
2	167.0	-5.2	19.7	+3.4	73.6	-9.6
3	147.6	-6.6	19.4	+3.5	55.5	-10.1
4	119.0	-7.5	19.0	+10.6	50.1	-10.9
5	117.7	-7.7	17.5	+14.4	69.1	-18.6
6	128,6	-9.0	19.2	+7.0	44.1	-8.7
7	136,0	-3.5	19.1	+8.5	53.6	-12.2
8	110,0	-4.0	19.6	+6.0	52.0	-8.6
average	-	-7.0	-	+7.6	-	-10.8

#### 4. LORENTZ FORCE DETUNING MONITORING SYSTEM

The monitoring part of the piezo control system is composed of signal conditioning and data acquisition circuits. The signal conditioning circuit was designed using instrumentation amplifiers (IA). The high frequency signals bandwidth is limited using RF input low-pass (LP) filters. The gain of amplifiers can be easily controlled using external resistor. The next version of the system is planned to be equipped with programmable gain amplifiers (PGA). The data acquisition part is based on fast 20 MSPS ADC device with external multichannel switching circuit. The multiplexing scheme was chosen to minimize the space on printed circuit board which allows integrating of 32 monitoring inputs. The block diagram of the monitoring system is depicted in Fig. 5.

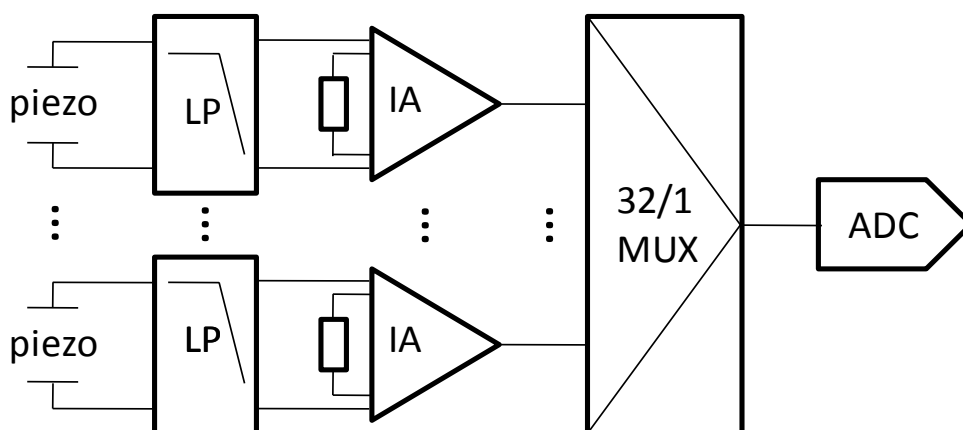

Fig. 5. The block diagram of piezo monitoring system.

Rys. 5. Schemat blokowy systemu monitorowania z czujnikami piezoelektrycznymi.

#### 4.1. Main functionalities of the monitoring system

The main functionalities of the piezo monitoring system are as follows.

- Lorentz force detuning detection – the piezo sensor voltage is proportional to the force which is mainly generated by RF field transferred to cavity,
- Piezo actuator polarity detection – the piezo element operated as an actuator can be connected to piezo driver with negative polarization, the piezo controller should be able to detect the polarity and change properly the sign of compensation pulse,
- Feedback operation – the existing controller is equipped with feedforward control scheme which is suitable for compensation of repetitive Lorentz force detuning during the RF pulse. The microphonics effect which is unpredictable (smaller impact to cavity detuning) for pulsed operated linacs is considered to be dumped using a feedback control scheme using actuator/sensor configuration. Since, the feedback control is not possible during the RF pulse mainly due to the mechanical wave propagation time delay along the cavity walls, it should be performed between RF pulses and with some time advance to the start of RF pulse.
- System identification – the transfer functions analyzed in time and frequency domains can be derived directly from measurements of piezo sensor signal and used for analytical fitting as well as modeling purpose of the plant (cavity with piezo actuator and RF field).

#### 4.2. Transfer functions – analysis and modeling

The typical responses of cavity to RF pulse measured using piezo sensor (piezo to RF transfer function) in time and frequency domains are shown in Fig. 6.

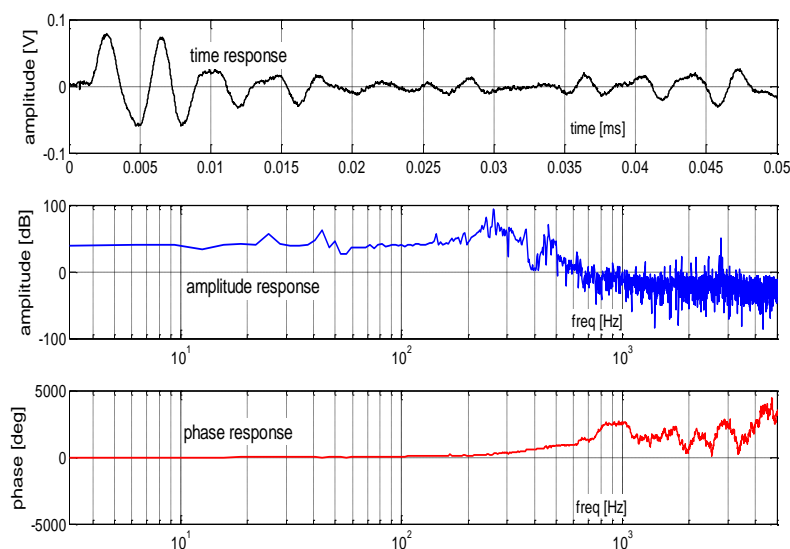

Fig. 6. Typical transfer functions of piezo to RF – time and frequency domain.

Rys. 6. Typowe funkcje przejścia piezo / pole RF – dla domeny czasu i częstotliwości.

As one can noticed the frequency domain data analysis give as some information about the character of the analyzed system. The cavity can be treated as higher order system with dominant frequency of order of 250 Hz and some time delay that can be directly estimated from phase characteristic. The frequencies below 102 Hz discovered in the spectrum can be generated by vacuum pumps or some slow frequency motors running during the normal operation of the accelerator. The higher frequencies ( $>10^3$  Hz) can comes from vibrations from outside world i.e. ground or just human activities.

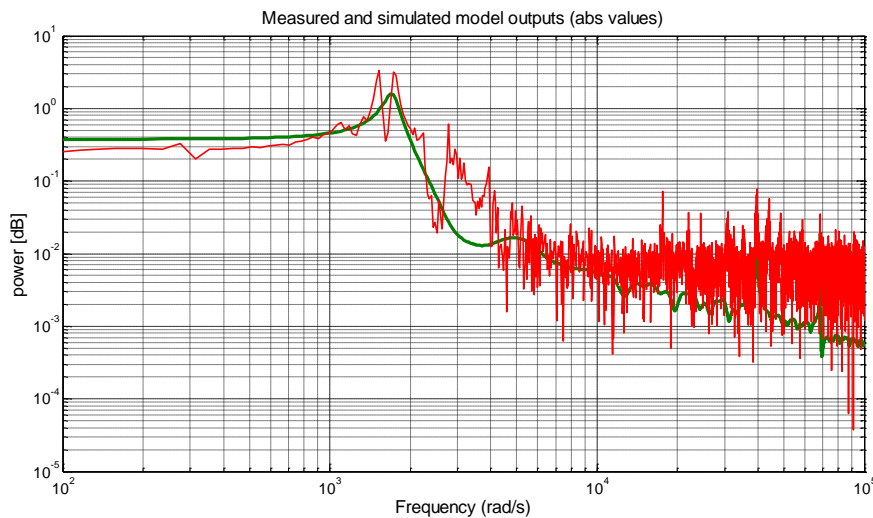

Fig. 7. The estimated model fitting result using 16th order PEM (prediction-error minimization) method from system identification toolbox.

Rys. 7. Dopasowanie modelu uzyskanego metodą minimalizacji błędu predykcji 16 rzędu, udostępnionej w oprogramowaniu system identification toolbox.

The accelerator system is accessible for various experiments and research with very limited time. Moreover the repair and upgrade activities can switched off the facility from usage for a long time periods. In order to allow developing and implementing various control methods the simple model of the cavity plant was derived. It is based on analytical fitting of the piezo to RF transfer function. The model estimation and verification was supported using Matlab - system identification toolbox [5]. The measured input and output signals were transformed from time to frequency domain representation. The state space model structure was chosen in case of easy further data pre-processing. The model fitting to the measured data is shown in Fig. 7. The model was imported to Matlab - Simulink toolbox and next the simple compensation method was applied and simulated (see Fig. 8).



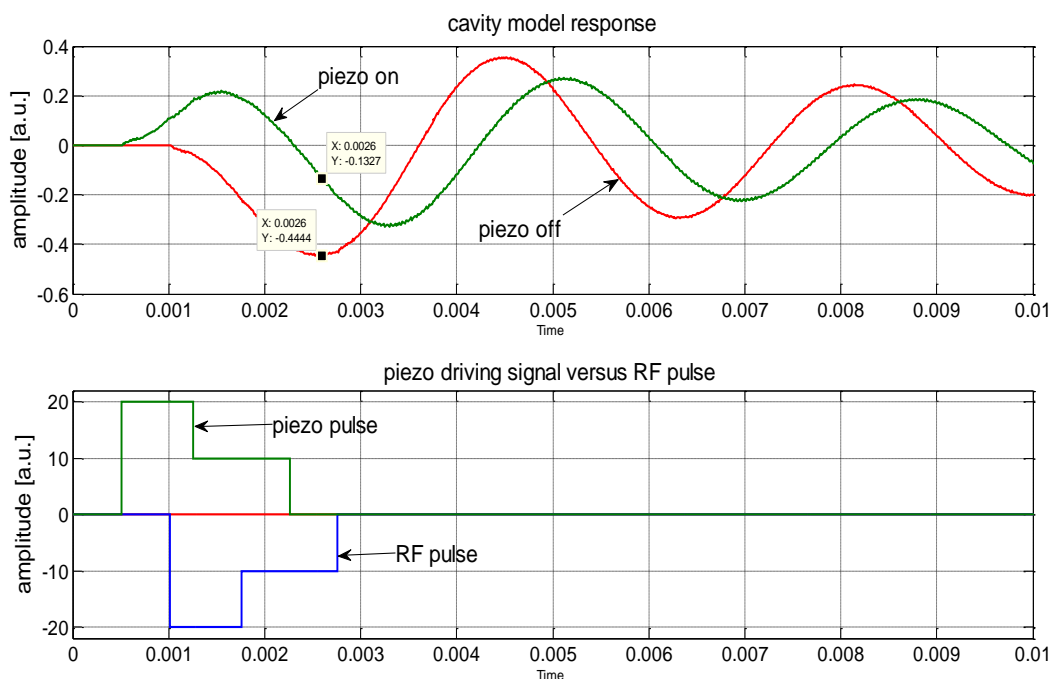

Fig. 8. The compensation method simulated using Matlab - Simulink toolbox

Rys. 8. Metoda kompensacji – symulacje z wykorzystaniem oprogramowania Matlab – Simulink toolbox

## 5. CONCLUSIONS AND FUTURE PLANS

The Lorentz force detuning compensation and monitoring system was installed in FLASH facility to support the high energy physics experiments. The compensation system efficiency was estimated to be around +8% of increased accelerating field together with reduction of cavity power reflection and needed RF power control correspondingly around -11% and -7%. The system is planned to be upgraded to handle the new accelerating modules with piezos (new ACC1 and ACC7) which will be assembled at FLASH in march 2010. Moreover the authors consider using the piezo actuator/sensor control mode which is planned to be added to the existing feedforward path of controller. The developed model of cavity system with RF pulse using a desired piezo to RF transfer functions can speed up simulation, development and implementation processes.

## REFERENCES

- [1] Simrock S. N.: Lorentz Force Compensation of Pulsed SRF Cavities, Proceedings of LINAC 2002, Gyeongju, Korea.

- [2] Lilje L.: High-gradient Superconducting Radiofrequency Cavities for Particle Acceleration, Proceedings of EPAC 2006, Edinburgh, Scotland.
- [3] Przygoda K., Poźniak T.: Mechatronic System for Compensation of Superconducting Cavities' Deformations, XII Symposium PPEE'2007, Wisła, Poland.
- [4] Przygoda K., Poźniak T.: System do kompensacji odstrojenia rezonansowych wnęk nadprzewodzących w akceleratorze FLASH, IX Konferencja Naukowa SENE'2009, Łódź, Poland.
- [5] Lennart L.: System Identification Toolbox™ 7 Getting Started Guide, MathWorks, Inc.

Recenzent: Dr hab. inż. Barbara Ślusarek

Wpłynęło do Redakcji dnia 10 kwietnia 2010 r.

### **Abstract**

The Free Electron Lasers (FELs) are a unique pulsed light sources which are used for a variety of modern sciences. The wavelength of generated spontaneous radiation is tunable in range of  $100\div 10$  nm, which makes it suitable for exploration of very small structures. An example of such machine is Free Electron Laser in Hamburg (FLASH). It is based on superconducting linac used for high energy beam generation required for FEL operation. SC linac of FLASH use superconducting (SC) resonant cavities for particle acceleration, operated at a radio frequency (RF) of a 1.3 GHz. The SC cavities are detuned from its resonance commonly due to repulsive magnetic forces and attractive electric forces (Lorentz forces) of an electromagnetic wave which is transferred to the cavity as a set of successively repeated pulses. The detuned cavities need more RF control efforts to achieve a desired energy of accelerated particles [1]. Therefore, the electromechanical structures commonly based on piezoelectric elements are used to tune the cavities to the resonance frequency. In order to achieve the demand requirements for piezo control, the dedicated electronic systems were designed and developed.

The piezos installed in FLASH facility are configured as follows: the ACC3 and ACC5 have tuners with single piezo while the ACC6 has double piezos. The tuners with double piezos can be used simultaneously as actuator and sensor. In order to handle such piezo configuration, the corresponding piezo control system was designed and installed in FLASH (see Fig. 2 right). It is equipped with three units of 8-channel piezo driver, 32-channel driving/sensing board (Piezo Control Board), Low-Level Radio Frequency (LLRF) control board (SimconDSP), industrial CPU (Sparc), Distributed Object Oriented Control System (DOOCS) and monitoring ADCs [4].

The Lorentz force detuning compensation and monitoring system was installed in FLASH facility to support the high energy physics experiments. The compensation system

efficiency was estimated to be around +8% of increased accelerating field together with reduction of cavity power reflection and needed RF power control correspondingly around -11% and -7%. The system is planned to be upgraded to handle the new accelerating modules with piezos (new ACC1 and ACC7) which will be assembled at FLASH in march 2010. Moreover the authors consider using the piezo actuator/sensor control mode which is planned to be added to the existing feedforward path of controller. The developed model of cavity system with RF pulse using a desired piezo to RF transfer functions can significantly speed up simulation, development and implementation processes.